

HOLDERS WIRE hammered

C192292



**WERSJA MATERIAŁOWA:**

hot galvanised steel

**OPIS:**

Hammered holder for routing the lightning conductor over wooden structures.

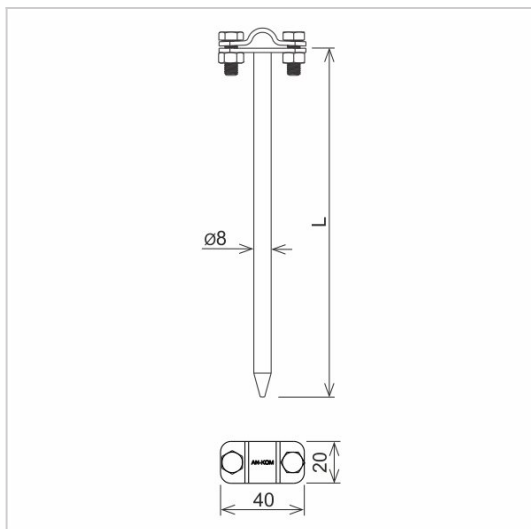

<b>symbol</b> typ	<b>C192292</b> AN-35/OG/
<b>L(mm)</b>	210
<b>conductor(mm)</b>	Ø8
<b>wersja materiałowa</b>	hot galvanised steel



AN-KOM 2 Sp. z o.o.  
Inwałd, ul. ks. Władysława  
Bukowińskiego 15  
34-120 Andrychów



an-kom.pl  
sales@an-kom.pl



tel./fax  
+48 605 527 132