

HOLDERS WIRE screw-in

C192356



WERSJA MATERIAŁOWA:

hot galvanised steel

OPIS:

Screw-in holder for routing the ground wire on the facade, wooden structures.

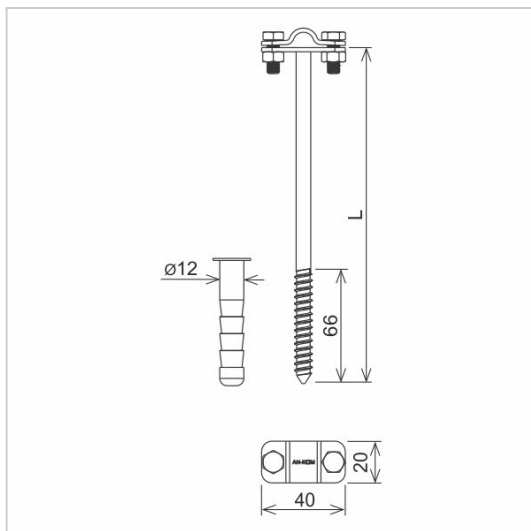

symbol typ	C192356 AN-44/OG/
L(mm)	250
conductor(mm)	Ø8
wersja materiałowa	hot galvanised steel



AN-KOM 2 Sp. z o.o.
Inwałd, ul. ks. Władysława
Bukowińskiego 15
34-120 Andrychów



an-kom.pl
sales@an-kom.pl



tel./fax
+48 605 527 132