

HOLDERS TAPE CONDUCTOR screw-in

C192360



**WERSJA MATERIAŁOWA:**

hot galvanised steel

**OPIS:**

Flat conductor (tape conductor holder) mounting holder with expansion bolt included. Wall or foundation mounting.

\*B - maximum tape conductor holder width

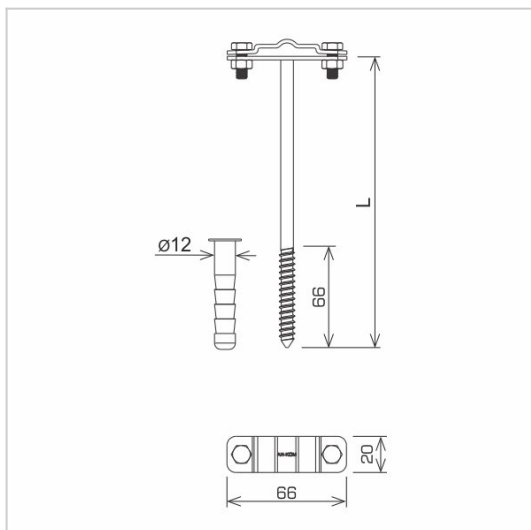

<b>symbol</b> typ	<b>C192360</b> AN-44A/OG/
<b>L(mm)</b>	250
<b>conductor(mm)</b>	B* to 30 or Ø8
<b>wersja materiałowa</b>	hot galvanised steel



AN-KOM 2 Sp. z o.o.  
Inwałd, ul. ks. Władysława  
Bukowińskiego 15  
34-120 Andrychów



an-kom.pl  
sales@an-kom.pl



tel./fax  
+48 605 527 132