

HOLDERS FOR SHEET, FELT, SHINGLE straight angle holder

C192596



WERSJA MATERIAŁOWA:

hot galvanised steel

OPIS:

Holders for conducting the ground wire on the roofs of buildings covered with shingles, roofing felt, sheet metal.

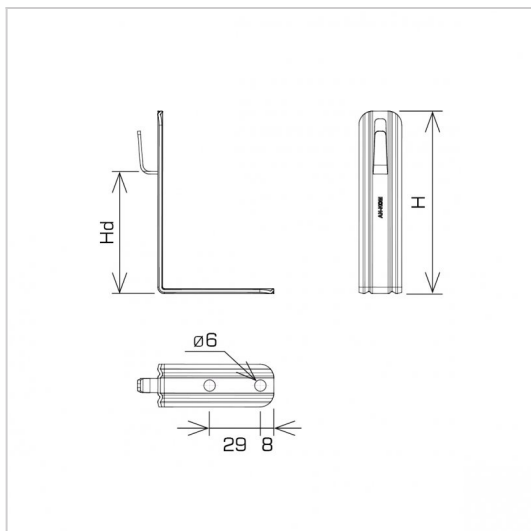

symbol typ	C192596 AN-11/OG/-N
H(mm)	124
Hd(mm)	90
conductor(mm)	Ø8
wersja materiałowa	hot galvanised steel



AN-KOM 2 Sp. z o.o.
Inwałd, ul. ks. Władysława
Bukowińskiego 15
34-120 Andrychów



an-kom.pl
sales@an-kom.pl



tel./fax
+48 605 527 132