

HOLDERS UNIVERSAL pipes and wires universal holders

C192712



WERSJA MATERIAŁOWA:

hot galvanised steel

OPIS:

Designed for fixing pipes / wires, offered in a wide range of sizes.

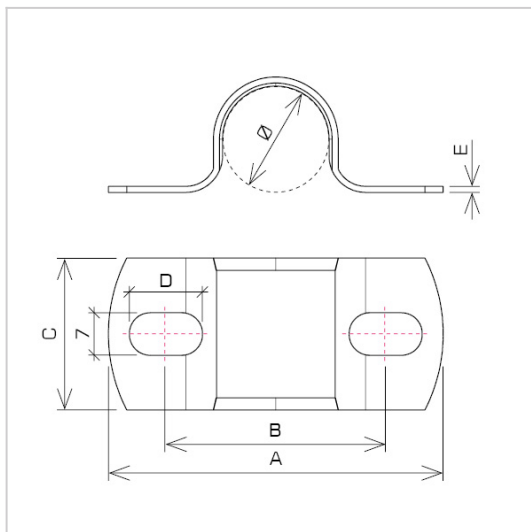

symbol typ	C192712 AN-RU8/OG/
Ø(mm)	26
A(mm)	70
B(mm)	51
C(mm)	30
D(mm)	12
E(mm)	1,5
wersja materiałowa	hot galvanised steel



AN-KOM 2 Sp. z o.o.
Inwałd, ul. ks. Władysława
Bukowińskiego 15
34-120 Andrychów



an-kom.pl
sales@an-kom.pl



tel./fax
+48 605 527 132