

HOLDERS UNIVERSAL pipes and wires universal holders

C192732



WERSJA MATERIAŁOWA:

hot galvanised steel

OPIS:

Designed for fixing pipes / wires, offered in a wide range of sizes.

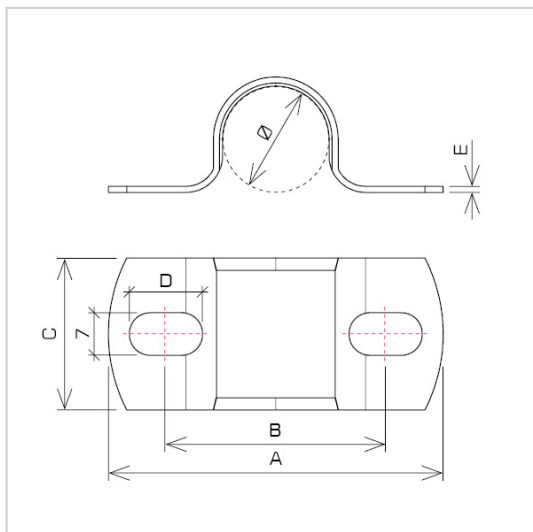

symbol typ	C192732 AN-RU13/OG/
Ø(mm)	43
A(mm)	85
B(mm)	62
C(mm)	40
D(mm)	14,5
E(mm)	1,5
wersja materiałowa	hot galvanised steel



AN-KOM 2 Sp. z o.o.
Inwałd, ul. ks. Władysława
Bukowińskiego 15
34-120 Andrychów



an-kom.pl
sales@an-kom.pl



tel./fax
+48 605 527 132