

HOLDERS WIRE screw-in

C282356



**WERSJA MATERIAŁOWA:**

stainless acid-resistant V4A steel

**OPIS:**

Screw-in holder for routing the ground wire on the facade, wooden structures.

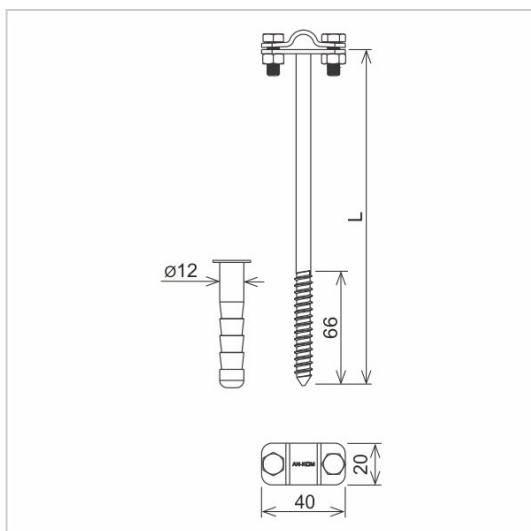

symbol	<b>C282356</b>
typ	AN-44/OH/
L(mm)	250
conductor(mm)	Ø8
wersja materiałowa	stainless acid-resistant V4A steel



AN-KOM 2 Sp. z o.o.  
Inwałd, ul. ks. Władysława  
Bukowińskiego 15  
34-120 Andrychów



an-kom.pl  
sales@an-kom.pl



tel./fax  
+48 605 527 132