

HOLDERS FOR SHEET, FELT, SHINGLE twisted angle holder

C372580

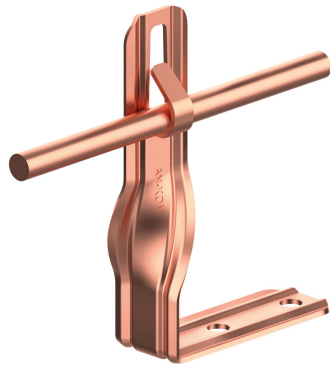

WERSJA MATERIAŁOWA:

copper

OPIS:

Holders for conducting the ground wire on the roofs of buildings covered with shingles, roofing felt, sheet metal.

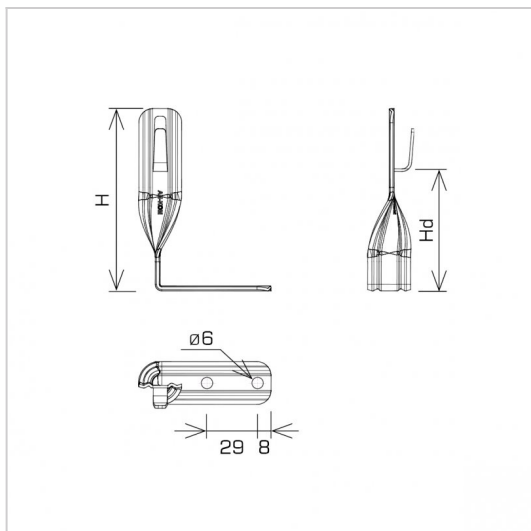

symbol typ	C372580 AN-09/CU/-N
H(mm)	124
Hd(mm)	90
conductor(mm)	Ø8
wersja materiałowa	copper



AN-KOM 2 Sp. z o.o.
Inwałd, ul. ks. Władysława
Bukowińskiego 15
34-120 Andrychów



an-kom.pl
sales@an-kom.pl



tel./fax
+48 605 527 132