

HOLDERS TAPE CONDUCTOR hammered

C462288

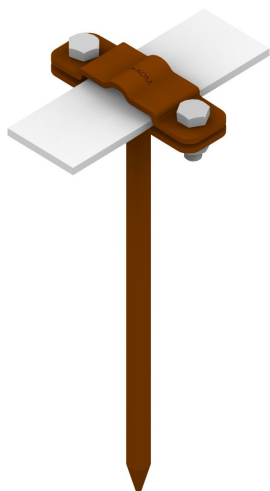

WERSJA MATERIAŁOWA:

painted

OPIS:

For routing flat conductors (tape conductor holder) along the wall or foundation. The holder designed for wooden constructions. Installation is done by hammering the handle into the ground.

*B - maximum tape conductor holder width

The holder is also used to mount the round conductor.

AVAILABLE COLOURS:

RAL 3011 - **red**, RAL 8017 - **dark brown**, RAL 7016 - **anthracite grey**,
RAL 7026 - **granite grey**, RAL 8004 - **brown (brick colour)**, RAL 9005 - **black**

DOSTĘPNE W KOLORACH

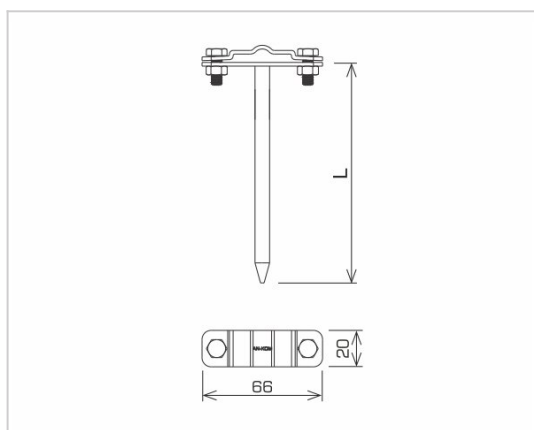

symbol typ	C462288 AN-33A/LA/
L(mm)	160
conductor(mm)	B* to 30 or Ø8
wersja materiałowa	painted



AN-KOM 2 Sp. z o.o.
Inwałd, ul. ks. Władysława
Bukowińskiego 15
34-120 Andrychów



an-kom.pl
sales@an-kom.pl



tel./fax
+48 605 527 132