

HOLDERS ROOF TILE universal twisted holder

E194620

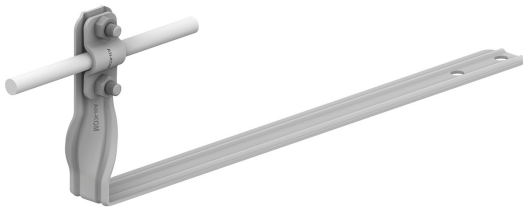

WERSJA MATERIAŁOWA:

hot galvanised steel

OPIS:

Tile holder - universal, twisted, used to build air terminals and lightning conductors on the roof along the tiles. The holder is mounted by screwing it to the batten through the mounting holes.

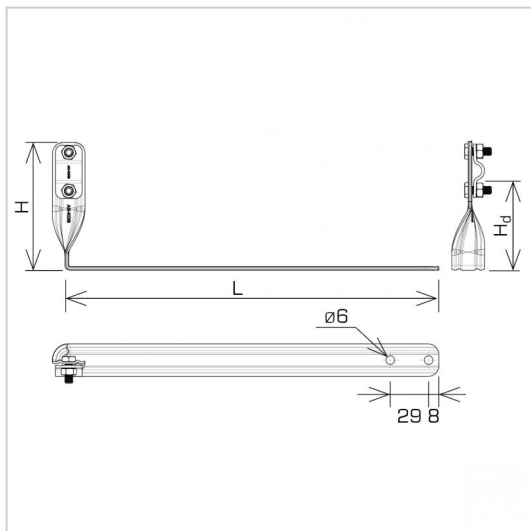

symbol	E194620
typ	AN-28/OG/-N
L(mm)	280
H(mm)	116
Hd(mm)	90
cable(mm)	Ø8
wersja materiałowa	hot galvanised steel



AN-KOM 2 Sp. z o.o.
Inwałd, ul. ks. Władysława
Bukowińskiego 15
34-120 Andrychów



an-kom.pl
sales@an-kom.pl



tel./fax
+48 605 527 132