

HOLDERS ROOF TILE universal straight holder

E194632

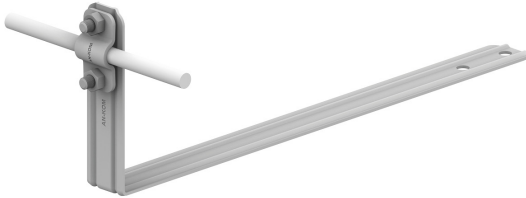

WERSJA MATERIAŁOWA:

hot galvanised steel

OPIS:

Tile holder - universal, straight, used to build air terminals and lightning conductors on the roof across the tile. The holder is mounted by screwing it to the batten through the mounting holes.

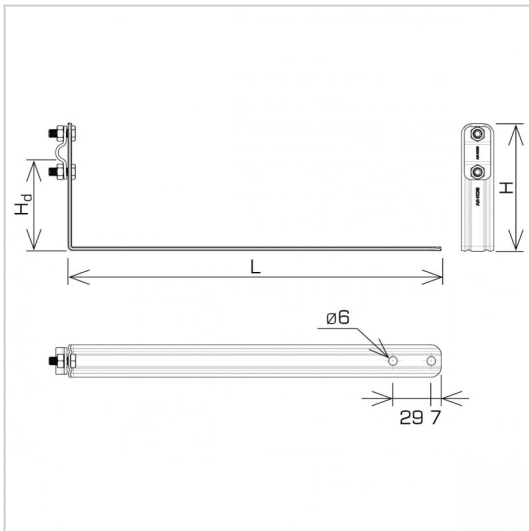

symbol typ	E194632 AN-25A/OG/-N
L(mm)	280
H(mm)	96
Hd(mm)	70
cablę(mm)	Ø8
wersja materiałowa	hot galvanised steel



AN-KOM 2 Sp. z o.o.
Inwałd, ul. ks. Władysława
Bukowińskiego 15
34-120 Andrychów



an-kom.pl
sales@an-kom.pl



tel./fax
+48 605 527 132