

HOLDERS ROOF TILE universal twisted holder

E464524

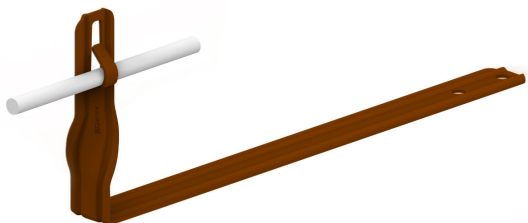

DOSTĘPNE W KOLORACH



WERSJA MATERIAŁOWA:

painted

OPIS:

Tile holder - universal, twisted, used to build air terminals and lightning conductors on the roof along the tiles. The holder is mounted by screwing it to the batten through the mounting holes.

AVAILABLE COLOURS:

RAL 3011 - **red**, RAL 8017 - **dark brown**, RAL 7016 - **anthracite grey**, RAL 7026 - **granite grey**, RAL 8004 - **brown (brick colour)**, RAL 9005 - **black**

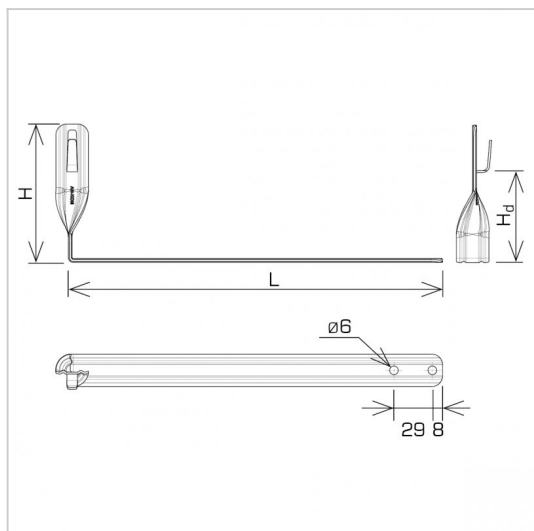

symbol	E464524
typ	AN-22/LA/-N
L(mm)	280
H(mm)	124
Hd(mm)	90
cablę(mm)	Ø8
wersja materiałowa	painted



AN-KOM 2 Sp. z o.o.
Inwałd, ul. ks. Władysława
Bukowińskiego 15
34-120 Andrychów



an-kom.pl
sales@an-kom.pl



tel./fax
+48 605 527 132