

Isolated air termination rods ISOLATING RODS type 3a holder

J196636

WERSJA MATERIAŁOWA:

hot galvanised steel

OPIS:

Holder with articulated clamp for screwing horizontal isolated rod. The catch is attached to the supporting pipe of the mast, while the horizontal insulating bar is mounted to the protruding thread.

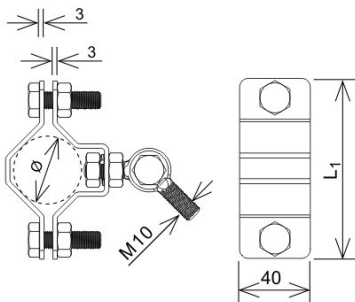

symbol	J196636
typ	AN-85A40/OG/
Ø(mm)	30 - 40
L1(mm)	90
screws	M10 x 35
wersja materiałowa	hot galvanised steel



AN-KOM 2 Sp. z o.o.
Inwałd, ul. ks. Władysława
Bukowińskiego 15
34-120 Andrychów



an-kom.pl
sales@an-kom.pl



tel./fax
+48 605 527 132