

AIR TERMINATION RODS MAST ACCESSORIES rod spires holder

J196668

WERSJA MATERIAŁOWA:

hot galvanised steel

OPIS:

The holder is used for mounting rod spires.

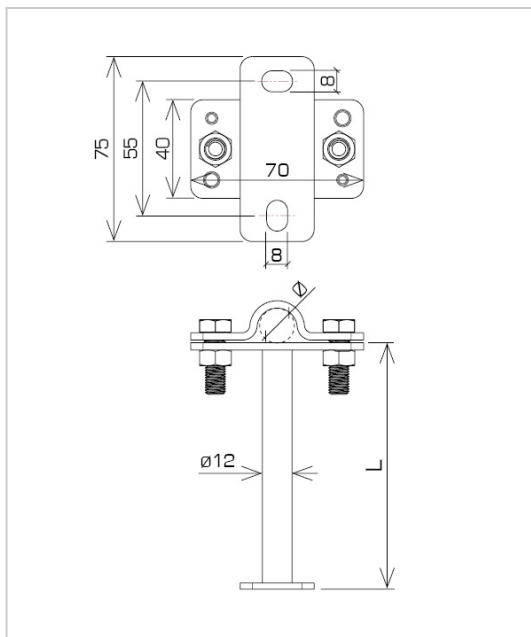
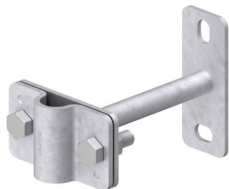

symbol	J196668
typ	AN-84L16/OG/
Ø1(mm)	16
L(mm)	100
screws	M8x30
wersja materiałowa	hot galvanised steel



AN-KOM 2 Sp. z o.o.
 Inwałd, ul. ks. Władysława
 Bukowińskiego 15
 34-120 Andrychów



an-kom.pl
 sales@an-kom.pl



tel./fax
 +48 605 527 132