

**UCHWYTY DO NACIĄGÓW UCHWYTY NACIĄGOWE wbijane podwójne**

**C282560**



**WERSJA MATERIAŁOWA:**

stal nierdzewna kwasoodporna V4A

**OPIS:**

Uchwyty do naciągów wbijane z dwoma otworami.

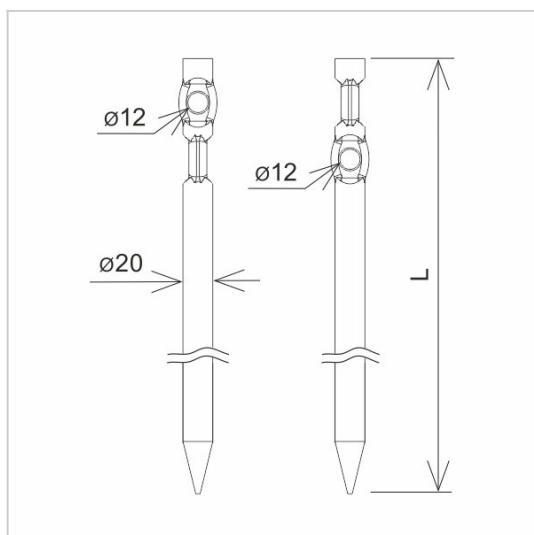

<b>symbol</b>	<b>C282560</b>
typ	AN-31D30/OH/
<b>L (mm)</b>	300
<b>wersja materiałowa</b>	stal nierdzewna kwasoodporna V4A



AN-KOM 2 Sp. z o.o.  
Inwałd, ul. ks. Władysława  
Bukowińskiego 15  
34-120 Andrychów



an-kom.pl  
biuro@an-kom.pl



tel./fax  
+48 33 875 18 11  
+48 33 870 60 88